

THE BRAZILIAN SATELLITE PROGRAM – A SURVEY

Ijar M. Fonseca[†] and Peter M. Bainum[‡]

The Brazilian space program creation dates from 1961. From that time up to now the country has taken actions towards the human resource development to work in the space area, has built a strong infrastructure to test and integrate satellites, and has accomplished the development and launching of two small low earth orbit (LEO) data collection satellites. The main goals of the Brazilian space program were established in a project called the Brazilian Complete Space Mission (MECB) in 1980. The Brazilian National Institute for Space Research (INPE – Instituto Nacional de Pesquisas Espaciais) has pursued those goals for almost 4 decades). Presently the INPE Brazilian space program is under the coordination of the Brazilian Space Agency (AEB). The INPE History will be always linked to the Brazilian Space Program since it was under this Institute coordination and execution that the program started and accomplished the launching of the Brazilian satellites. This paper gives an overview about the Brazilian Complete Mission (MECB) with main focus on the Data collection and scientific Satellites developed and launched under the INPE coordination. Also the paper enhances mainly aspects of space mechanics and control features of the satellite designs. The lessons learned during the development of both the SCD-1 and SCD-2 satellites served as a strong guide for the satellites under development at INPE, presently under the coordination of the AEB. The result of the past experience provided the country with capability and a reasonable maturity to develop spacecraft.

INTRODUCTION

On August 03 1961, Jânio Quadros, then Brazil's president, created the GOCNAE (The Organizing Group of the National Commission for Space Activities) under the coordination of the CNPq (National Council for Technological Research) in order to

[†] Professor and Control Engineer, Space Mechanics and Control Division, INPE, S. J. Campos, SP, Brazil, E-mail: ijar@dem.inpe.br

[‡] Professor Emeritus, Howard University, Department of Mechanical Engineering, Washington D.C., 20059. E-mail: pbainum@howard.edu

provide the country with the infrastructure necessary for the exploration of outer space. The GOCNAE became known shortly by CNAE (National Commission for Space Activities). The group activities gave birth to the Space Research Institute that in 1971 came to be the National Institute for Space Research, INPE. Initially the activities developed at INPE involved research areas related to space and atmospheric sciences. The activities expanded and evolved to space applications areas, mainly remote sensing and meteorology, and space technology development, in particular satellites and the ground associated systems. The Brazilian initiatives towards space gained a new impulse by 1979 with the creation of the Brazilian Complete Space Mission (MECB). INPE comprises now various research institutes. The Brazilian space activities compose just one of them. Presently those space activities are formalized in the MECB^{1,2}.

The motivation that pushed Brazil towards the space conquest involves the country's continental area with large regions covered by immense extension of rain forest (most of the Amazon region is inside Brazil's territory), large regions stroked by large periods without rain and with serious social problems related to sickness and poverty. Large regions sparsely inhabited and with a very weak infrastructure regarding roads and energy to support local industrial development. In contrast the South and the South East regions of the country involve states that, if taken separately, would be as well developed and advanced as the world's most developed countries. The diversity and large size of a land of contrasts^{3,4}. The premises that guided the country towards space include the fact

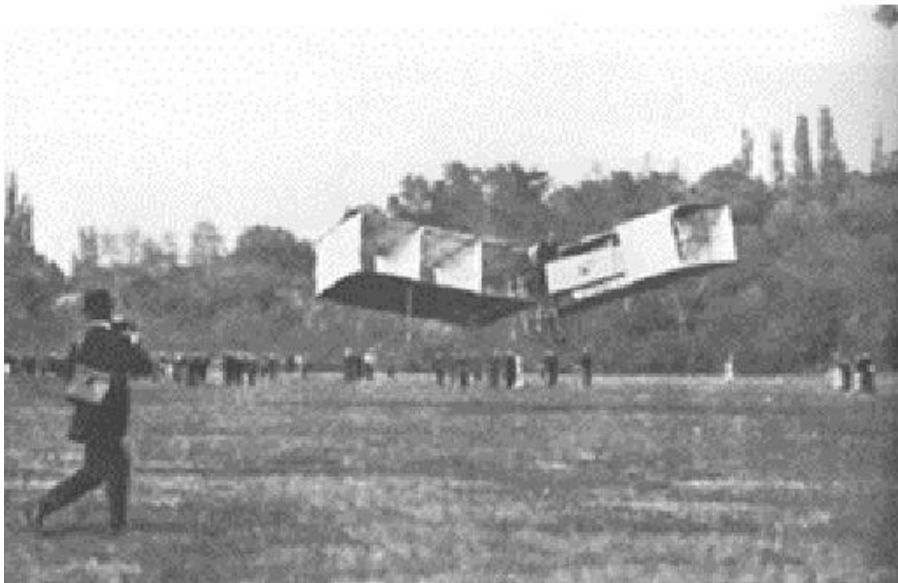

Figure 1 The 14-bis Plane – Brazilian Alberto Santos Dumont Flight: The First Heavier-than-air Officially Recognized Flight, Europe, 1906

that space could provide better knowledge of all the different regions and could help planning and controlling agricultural activities, the deforestation, and the weather prediction. In addition, the use of satellites could provide the country with better and efficient telecommunication systems. Furthermore, the Brazilian wide territory provides an excellent place to develop a satellite launch base, very close to the equatorial line.

Another story that brings about Brazil in space is the fact that the Brazilians have demonstrated throughout History a strong tendency to participate in the human effort toward the development in aerospace, as it was in Paris, 1906, with the Brazilian Alberto Santos Dumont 14-bis flight, the first heavier-than-air controlled aircraft flight^{5,6} (Figure 1). Presently the country confirms that tendency by being among those countries that conquered space not only with INPE's remarkable presence in space, but also with EMBRAER, the Brazilian aircraft company that is recognized in all of the world by the quality and excellence of the aircraft it produces. The space conquest involving an environment without atmosphere and embedded in a microgravity environment is a History the country is helping to write. INPE's excellent reputation in the space area is recognized by most of the best institutions and organizations related to space in the world.

However, to get into space would require coordinated and planned actions before accomplishing the goals of getting there. There was a long way ahead since that beginning in 1961. The country had to invest on infrastructure to support, integrate and test spacecrafts; on human resource development to work in the space area, on software system development to simulate, predict and control orbit and attitude among other challenges. Regarding human resource development the country established a doctoral program supported by CNPq, CAPES, and FAPESP for space research subjects. Hundreds of students have been sent abroad (USA, Canada, Germany, French, Japan, and England) to get their Ph.D. or Doctorate degrees in Flight Mechanics or other space related areas. Many of those students became leaders in human resource preparation in the country's universities and research institutes and also were engaged in the space program developments. It is worthy to note that the Brazilian space program effort towards space counted on the contribution of many scientists and space area specialists from different countries of the world. Sometimes they contributed by coming to INPE for conferences, short courses and training people (Malcolm Shuster then from APL, Peter M. Bainum from Howard University, Bernd Schaeffer from DLR, Ramon de Paula from NASA Headquarters, Luc Fraiture and R. Munch from ESA-ESOC, Mikhail Pivovarov and Alexander Sukhanov from IKI, Moscow and many others). Others came and stayed in the institute for some time (from months to years) through joint space projects and/or as visiting researchers. The foundation of the Brazilian space program has been built on the basis of effort, persistence, idealism, international cooperation, and a peaceful relationship with countries from different political and economic regimes, with different history and religions. The space joint programs/activities with the USA, China, Russia, Japan, France, Canada, India, and Germany among others are examples of the country's capability to manage to work with many different people around the world.

MECB – THE BRAZILIAN COMPLETE SPACE MISSION

The scope, the main objectives and directions of the Brazilian space program were established in a project called the Brazilian Complete Space Mission (MECB)^{1,2}. The project was approved in 1979. The MECB initially involved civilian (INPE) and military institutions (Ministry of Aeronautics) separately. These institutions were, for the civilian side, the Secretary of Science and Technology. This secretary was replaced by

the Ministry of Science and Technology. In this context the INPE space segment was directly under that Ministry until the last year (2004). Presently the Brazilian Space Agency (AEB) is responsible for the whole Brazilian space program coordination and the INPE space program is under AEB supervision. Regarding the military side of the Brazilian space program, the Ministry of Aeronautics is still responsible for the Satellite Vehicle Launcher (VLS) and the satellite launching base developments. However, these programs also are now under the AEB coordination. The main goals stated in the MECB are the design, development, launching and operation of two small low Earth orbit (LEO) Data Collection satellites (SCDs – Satélites de Coleta de Dados), and two remote sensing satellites (SSRs - Satélites de Sensoriamento Remoto)⁷⁻⁹. The space program includes the ground facilities, a laboratory for satellite integration and tests, and the design, construction and implementation of a launching base center at Alcântara (CLA – Centro de Lançamento de Alcântara, located at 2°17' S, 44°23' W, in the State of Maranhão). The main MECB objectives can be summarized as

1. To develop human resources and related infrastructure so as to support space activities in Brazil;
2. To call for partnership with industry in the task of developing space technologies;
3. To develop satellites with applications related to specific Brazilian needs (including those of interest to low-latitude regions worldwide);
4. To arrange for Brazil to participate in international space programs

The MECB has been extended along the years to include other satellites and programs such as the Scientific Satellites Program. Also the Brazilian space program includes the Brazil-China joint Earth Resource Satellites (CBERS – China Brazil Earth Resource Satellite) program.

This paper deals only with satellite programs. However, there is another side of the story of the Brazilian space program, involving much more difficulties: the activities to accomplish the goal of developing the Brazilian Satellite Launch Vehicle (VLS). This part of the Brazilian space program is still under way. The VLS development has been characterized by failures that caused the loss of some satellites and human lives. The last accident with the VLS, an unexpected ignition, caused the death of 21 people among engineers and technicians in addition to the satellite mission loss.

THE DATA COLLECTION SATELLITES (SCDs) SERIES – HISTORY, DEVELOPMENT, AND LAUNCHING

The SCD-1, the first of the SCDs series, was the greatest challenge the Brazilian managers, engineers, and researchers faced to put the country into the space club. During the satellite development its concept has changed from a gravity-gradient to a spin stabilized configuration. During the first phase of the satellite project the INPE engineers and researchers went through the gravity gradient stabilization theory and implementation. The first satellite configuration is illustrated in Figure 2. The spacecraft gravity-gradient stabilized configuration required complicated dynamics analysis involving a flexible in-orbit deployable 10 meters long boom with 3 Kg tip mass. When the stabilization technique was changed to the spin stabilization other challenges had to be overcome such as the definition, design, and development of a nutation damper^{7,8}.

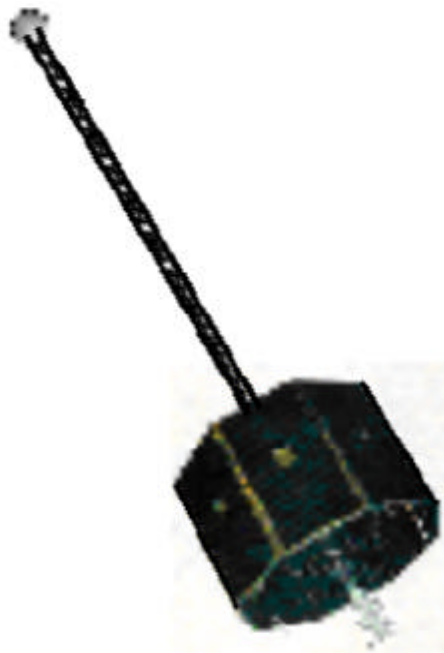

Figure 2 SCD-1 Gravity Gradient Stabilization Configuration

From the point of view of attitude and orbit dynamics and control the project involved mathematical modeling, simulations and the construction and tests of the nutation damper using an air bearing table to validate the computer programs and the damper performance. Then the satellite had to emerge from papers to the LIT⁹ for integration and tests. The SCD-1 project gave birth to some master's dissertations and even doctoral programs, and several papers¹⁰⁻²³. Figure 3 shows the SCD-1 test at LIT, the integration

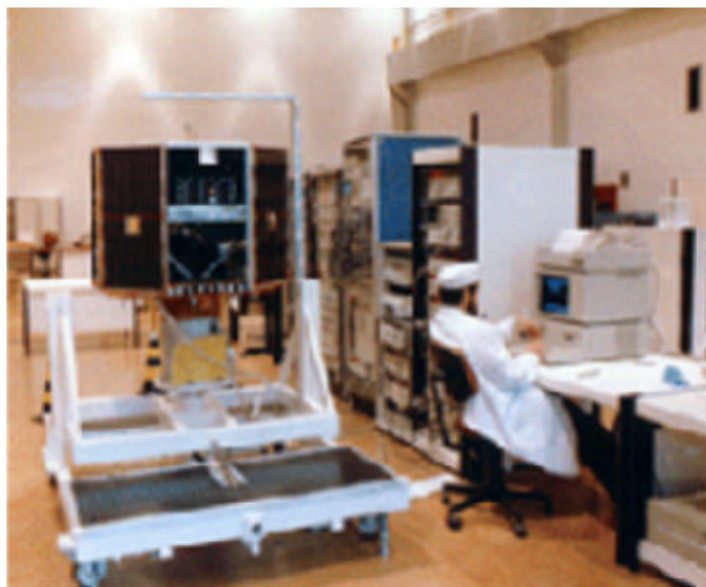

Figure 3 SCD-1 Test at the INPE's Integration and Test Laboratory, LIT

and test laboratory. The SCD-1 was launched on February 09, 1993 by the Orbital Science Corporation Pegasus rocket, from Florida, USA. The Pegasus rocket consolidated the possibility to launch successfully small satellites from a small rocket released from an aircraft. The 110 Kg satellite was injected into a 760 km LEO for a collecting data mission. At a 13 Km altitude the rocket was released in a free fall for five seconds. Then the rocket was ignited. Twelve years passed and the SCD-1 is still in operation. The predicted lifetime was much less than twelve years (just one year!). This is another story that some engineers and researchers in the institute use to tell to enhance that the best engineering procedures were the guidelines for the project development.

Some curious facts are associated with this long lifetime. For example, prediction studies stated that the SCD-1 spin rate would drop in one year to a level that would make the spacecraft lose its spin stabilization feature. However, the reality has shown that the spin rate, after dropping from 120 to about 50 rpm stopped dropping or entered in a very slow decay process! It will not be because of spin decay that SCD-1 will die. Maybe the battery will stop the SCD-1 heart beating some time in the near future. Meanwhile the satellite continues collecting data from data collection platforms (PCDs – Plataformas de coleta de dados). The PCDs are small automated ground stations usually situated in remote sites of very difficult access. Data acquired by the PCDs are transmitted to the satellites that relay them to INPE ground stations located in Cuiabá and Alcântara. From these stations, the data are then transferred to the Mission Center, in Cachoeira Paulista, for processing and immediate distribution to the users. Figure 4 illustrates the data flux from Earth to the satellite and then backs to ground. Data already processed are also available on Internet for registered users.

The SCD-1 satellite is a data collection satellite with the following characteristics:

1. Shape: octagonal base prism
2. Dimension: 1m diameter, 1 m height
3. Mass: 110 Kg
4. Power: 110W
5. Structure: Aluminum honeycomb panels
6. Stabilization: spin, 120 rpm (passive stabilization)
7. Thermal Control: Passive
8. Data Collection Transponder on UHF/S bands
9. TT&C on S-band
10. Solar Cells Experiment
11. Orbit: circular, 750Km altitude, 25 degrees of inclination



Figure 4 Data Collection Satellite and Collection Platforms

The SCD-1 is spin stabilized in attitude (120 rpm just after the orbit injection). The spacecraft has the shape of an octagonal prism. All of the satellite faces, except one, are covered by solar cells. The satellite thermal control subsystem uses the uncovered face for heat dissipation purposes. Because of this the direct incidence of solar light on that face is prohibited. The illumination of that face could cause thermal problems and then damage the satellite equipment. One form to guarantee the non illumination of that side would be by keeping the solar aspect angle smaller than 90° . A satellite thermal analysis performed just after the satellite launching revealed that the critical heating of the payload would happen in case the solar aspect angle reached values less than 60° . Considering these results the imposed requirement on the solar aspect angle was set to be greater than 60 degrees and an allowable angular variation became tolerable in the range from 60° to 90° . As a consequence of this range restriction the SCC (Satellite Control Center) is required to command a spin axis maneuver whenever the angle approaches one of those angle boundaries. The critical configuration is determined through the SCD-1 attitude determination process. The control actuation is produced by activating, via telecommand, the ACS magnetic coil which, by interaction with the Earth's magnetic field, produces the necessary torque to reorient the vehicle spin axis. Also the ACS comprises a partially filled ring nutation damper to correct any nutation motion imparted to the satellite by the rocket separation system or any other attitude disturbance. Attitude determination is achieved from solar sensors and one magnetometer.

Electrical power is generated by eight rectangular lateral faces of the satellite's octagonal shape and one octagonal top solar array, comprised by silicon cells. One power

conditioning unit (PCU) receives and distributes the generated power to all the satellite subsystems. A Nickel-cadmium battery stores energy for SCD-1 operation during eclipse. The excess power generated is dissipated on two shunt dissipaters located on the bottom panel. One DC/AC converter and one power distribution unit complete the subsystem equipment.

Two computers compose the onboard supervision subsystem. This system allows for the alteration of the remote software from the ground so that remote reprogramming/correction is possible. The system configuration allows time-tagged commands and stored telemetry for transmission when under coverage from the ground stations. INPE has developed a control system named SICS (Satellite Control System) in order to control the in-orbit first Brazilian satellite (SCD-1) launched in February 1993. When in orbit, satellites need to be monitored and controlled by the Ground so that they could execute the services they are designed for. The Telemetry Tracking and Command (TT&C) Ground Segment operation and maintenance as well as the satellite operation in orbit are done by the Tracking and Control Center (CRC) of INPE. The CRC²⁴ is composed by the Satellite Control Center and the Cuiabá and Alcântara Stations. The Satellite Tracking and Control Center operations are performed on the main campus at São José do Campos and at the regional facilities in Cuiabá-MT and Alcântara-MA. The TT&C stations are the interface between the satellites and the Satellite Control Center. They are equipped with parabolic antennas and Radio Frequency equipment to transmit satellite telecommands generated in the Satellite Control Center and to receive the telemetry data from the satellites and send them to the Satellite Control Center. The connection between the Cuiabá and Alcântara TT&C stations and the Satellite Control Center is provided by a private data communications network. The SCD-1 is still operating.

THE SECOND DATA COLLECTION SATELLITE, SCD-2

The second of the SCDs, the SCD-2, was launched successfully on October 1998 by another Pegasus rocket, also from Florida, USA. This time the aircraft was a L-1011 and the Pegasus rocket had been attached to the “belly” of the aircraft instead of being attached on a wing as it was for the SCD-1 launching. Figure 5 shows the pre-launching aircraft-Pegasus configuration. The SCD-2 is very similar to the SCD-1 in many aspects, except for some improvement incorporated to the project. One very important characteristic of the SCD-2 is that most of the on-board equipments were designed and developed at INPE or by the Brazilian industry. Table 1 shows some properties of both the SCD-1 and SCD-2.



Figure 5 Pegasus Under the L-1011 Aircraft

**TABLE 1
SCD-1 & SCD- 2 SATELLITES**

Satellite Properties	SCD-1	SCD-2
Lifetime	1 yr., 75% reliability	2 yrs., 65% reliability
Nationalization index	73%	85%
Cost (US\$ millions)	19	11
Spin rate	120 rpm (passive control)	34 rpm (active control)
Payload	Onboard computer Solar cell experiment	Onboard computer Solar cell experiment Reaction wheel
Spin axis orientation	Variable	Always normal to the Sun

The SCD-2 spacecraft carries a payload experiment, a non-flywheel reaction wheel, for future application to 3-axis satellite stabilization. SCD-2 differs from SCD-1 for including a second magnetic torque coil to control the spin rate, keeping it between 32 and 36 rpm.

The second environmental Data Collection satellite developed by INPE, the SCD-2, was launched on October 22, 1998, by the American launcher Pegasus, a vehicle similar to which inserted in orbit the SCD-1. The airplane L-1011 transporting Pegasus with the SCD-2, took off from Cape Canaveral AF Base, Florida at 21:05 (Brazil local time). Over the Atlantic, 57 minutes after the take off, the launcher Pegasus with the SCD-2 was released from the airplane. The ignition of the first stage happened 5 seconds after the release of the rocket. Exactly at 22:12:57 (about 11 minutes after the ignition), the separation between the satellite and the launcher last stage occurred, which successfully ended the orbit insertion of the SCD-2. Approximately 12 seconds after the separation between the satellite and the launcher third stage, the SCD-2 entered into the coverage the region of Alcântara ground station. The ground station immediately acquired the satellite signal, which indicated that the satellite housekeeping transmitter that should be activated automatically during the separation was successfully activated. The received telemetry indicated that the satellite did not present any working problem. The SCD-2 orbit injection occurred with a high degree of fidelity to the designed orbit.

The satellite was injected into an orbit quite close to the nominal one, as can be verified by comparing the values of the nominal and actual parameters, which are presented in the Table 2. The application of the flight dynamics procedures followed a routine very similar to the one followed for the SCD-1.

TABLE 2
NOMINAL AND ACTUAL ORBIT ELEMENTS OF THE SCD-2 SATELLITE

Orbit Element	Nominal value	Actual value
Semi-major axis (m)	7133893	7128550
Eccentricity	0.000756	0.000023
Inclination (°)	24.987	25.001
Right ascension of the ascending node (°)	219.912	219.774
Argument of perigee (°)	348.543	291.050
Mean anomaly (°)	124.478	183.595
Injection time (Brazil local time)	23/10/1998 22:12:01.12	23/10/1998 22:12:57

Two additional constraints were imposed on the SCD-2 orbit concerning its relative positioning with SCD-1. Both satellites perform 14 orbits every 24 hours. Due to the 25° inclination of the orbit plane relative to the Equator, only 8 orbits are visible to the Cuiabá ground station range. In this way, in 24 hours there is a time interval corresponding to 6 orbits (approximately 10 hours) during which there are no SCD-2 passes over Cuiabá. Taking this into account, the orbit parameters of the SCD-2 was chosen in a such way that its cycles of sequential passes over Cuiabá are complementary to the ones of the SCD-1. During the periods in which there are no passes of one of the satellites then, there are passes of the other one. Besides, the SCD-2 were spaced from the SCD-1 in the orbit in such a way that a pass of one satellite will only happen some time after the pass of the other. It was verified that both constraints were perfectly respected in the launching. Concerning the satellite attitude after the orbit injection, it was very close to the nominal. The most restrictive attitude constraint to be respected, was that the sun light could not directly reach the upper and lower satellite faces with an incidence angle greater than 10°. This means that the sun aspect angle, directly measured by the sun sensors, shall be maintained between 80° and 100°. The sun sensor measurements indicated that, after the SCD-2 orbit injection, this angle was of 90.3°, quite close therefore to the ideal value of 90°. Currently, more than two years after launch, all the SCD-2 subsystems present a thoroughly satisfactory performance. Differently from the SCD-1, the SCD-2 has an autonomous system for spin rate control, by magnetic actuation. This system maintains the satellite spin rate between 32 and 36rpm. The Attitude Control Subsystem showed a very satisfactory overall performance during the entire SCD-2 operation period. Thanks to the execution, by telecommands, of spin axis maneuvers, the sun aspect angle was confined to its nominal variation range, rigorously respecting the imposed constraints. Concerning the satellite attitude after the orbit

injection, it was very close to the nominal. The most restrictive attitude constraint to be satisfied was that the sun light should not directly reach the upper and lower satellite faces with an incidence angle greater than 10°. This means that the sun aspect angle, directly measured by the sun sensors, shall be maintained between 80° and 100°. The sun sensor measurements indicated that, after the SCD-2 orbit injection, this angle was of 90.3°, quite close therefore to the ideal value of 90°.

There was a third SCD satellite, called SCD-2A. This satellite story involves the other side of the MECB: the satellite vehicle launcher (VLS –Veículo Lançador de Satélites) development. The SCD-2A was a simplified version of the SCD-2 and was used to test and qualify the VLS-1, the first Brazilian satellite launcher. Unfortunately one of the lateral boosters did not ignite and the VLS had to be destroyed. This was just one of three launcher failures that led to the collapse of other space missions: SACB and SACI-2. One of the accidents happened recently and caused the death of 21 people among them engineers that had worked for years in the launch vehicle development. A summary of the SCDs is shown in table 3.

**TABLE 3
SUMMARY OF THE STATUS OF THE SCDs**

Satellite	Date	Launcher	Remarks
SCD-1	09.02.1993	Pegasus	In orbit
SCD-2	23.10.1998	Pegasus	In orbit
SCD-2A	02.11.1997	VLS	Mission failed

THE SCIENTIFIC SATELLITES – SACIs SERIES AND EQUARS

The scientific application satellites developments are part of the PNAE decennial program for the period of 1996-2007. According to the PNAE subprogram that comprise the scientific satellites the objective is the development of small low cost satellites for short time missions which offer to the academic community the means to accomplish meritorious scientific experiments. In addition these satellite missions are supposed to create opportunities for the involvement of new groups from Brazilian universities into the space activities. Furthermore it is desirable that the scientific satellites programs be developed within an international cooperation to increase the scientific and technological interchange. Also scientific satellites shall serve as a means to test new concepts and solutions under limited risk conditions. According to these guidelines two small scientific satellites belonging to the SACIs (Scientific Application Satellites) series have been developed, the SACI-1 and SACI-2.

The SACI-1 Mission

The satellite has been developed by following the philosophy of being smaller, cheaper, and better. The scientific application satellite (SACI-1)²⁵⁻²⁷ is a 60 Kg small satellite carrying experiments for scientific purposes at 750 Km altitude polar orbit. The satellite carries four scientific payloads in order to investigate plasma bubbles in the geomagnetic field, airglow, and anomalous cosmic radiation fluxes. It also carries various platform technology developments. The spacecraft has four deployable panels. The ground segment comprises two main stations, and user ground Data Collection stations.

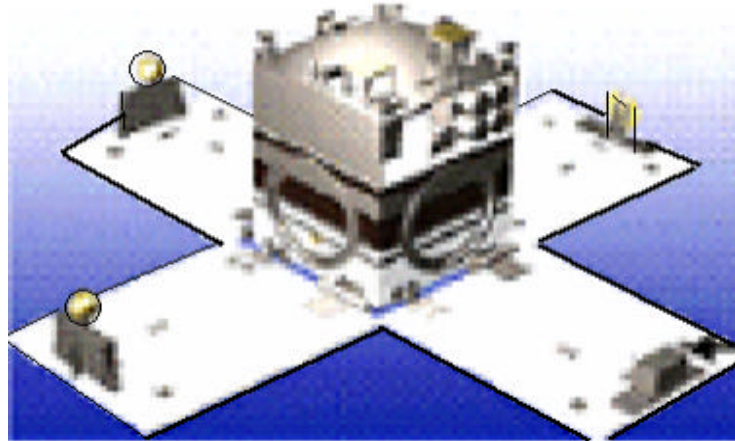

Figure 6 SACI-1 In-orbit Configuration

The attitude control combines passive spin stabilization with active geomagnetic attitude control. The main task of the Attitude Control Subsystem (ACS) is to maneuver the vehicle to point its solar panel towards the Sun; to execute the satellite spin up; to keep the attitude and spin rate close to the nominal specifications during the satellite lifetime. The satellite utilized by a piggyback launching by the Long LM-4B Chinese rocket (on the 14th October 1999) from the Taiyuan launch site. The satellite was placed into a 732×747 km sun-synchronous orbit together with the joint Chinese and Brazilian remote sensing satellite, as the primary payload. The satellite has been developed at INPE and, consistently with the PNAE recommendations the project involved universities and international cooperation. Unfortunately a failure into the satellite communication system resulted in the mission loss. The satellite has been inserted in the correct orbit. However, the ground stations never received a signal from the satellite. The in-orbit configuration is shown in Figure 6.

NORAD has confirmed the satellite in the correct orbit and that the solar panels have been deployed. This means that at least for some time the onboard computer worked since the solar array deployment was under the onboard computer command. The fully autonomous satellite could not receive any remote command from the ground station. The mission loss has been followed by an audit at INPE. However, the cause of the mission failure has never been clarified.

The SACI-2 Mission

This is another story of failure. The satellite was to be launched by the VLS-2. However the rocket second stage failed to ignite and the satellite has been lost. The SACI-2 configuration was quite different from the SACI-1. It was a hat shaped spacecraft as shown in Figure 7. However the ACS subsystem was similar to that of the SACI-1. The purposes of the SACI-2 mission were scientific and Data Collection. Unfortunately it could not carry out these experiments (The same as those of SACI-1: ORCAS (Solar and Anomalous Cosmic Rays Observation in the Magnetosphere), PLASMEX (Study of Plasma Bubbles), F TOEX (Airglow Photometer), and MAGNEX (Geomagnetic Experiment)) to implement the scientific side of the mission. As a Data Collection satellite SACI-2 would have collect environmental data like temperature, air humidity, wind direction, and atmospheric pressure from ground platforms located all over the Brazilian's territory and retransmit them to a Control Center located in São Paulo where the data would be processed. SACI-2²⁸⁻³⁰ was a 85 kg low Earth orbit (LEO) satellite combining passive stabilization procedure with active geomagnetic attitude control. The

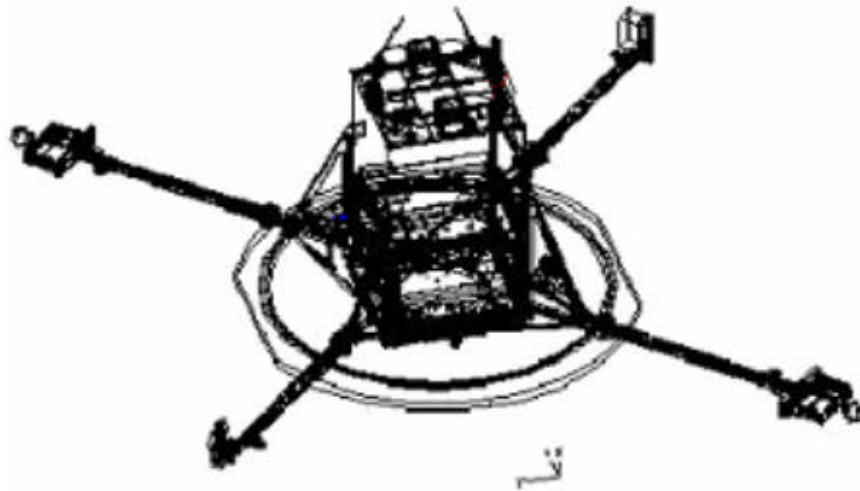

Figure 7 SACI-2, Deployed Arms Configuration

central body of the satellite was like a cube and the solar array was like a hat brim. For practical purposes the solar array was designed and made as rigid as possible so that the spacecraft would be injected into its orbit in that configuration (Figure 7, In-orbit configuration). It means that no solar panel deployment operation would be necessary. On the other hand the spacecraft was comprised of four mechanical arms that would be deployed in orbit. The main application of the arms was to keep the sensors away from the satellite electronics. Furthermore the deployed configuration of the arms together with the solar array would guarantee the major axis rule for spin stabilization.

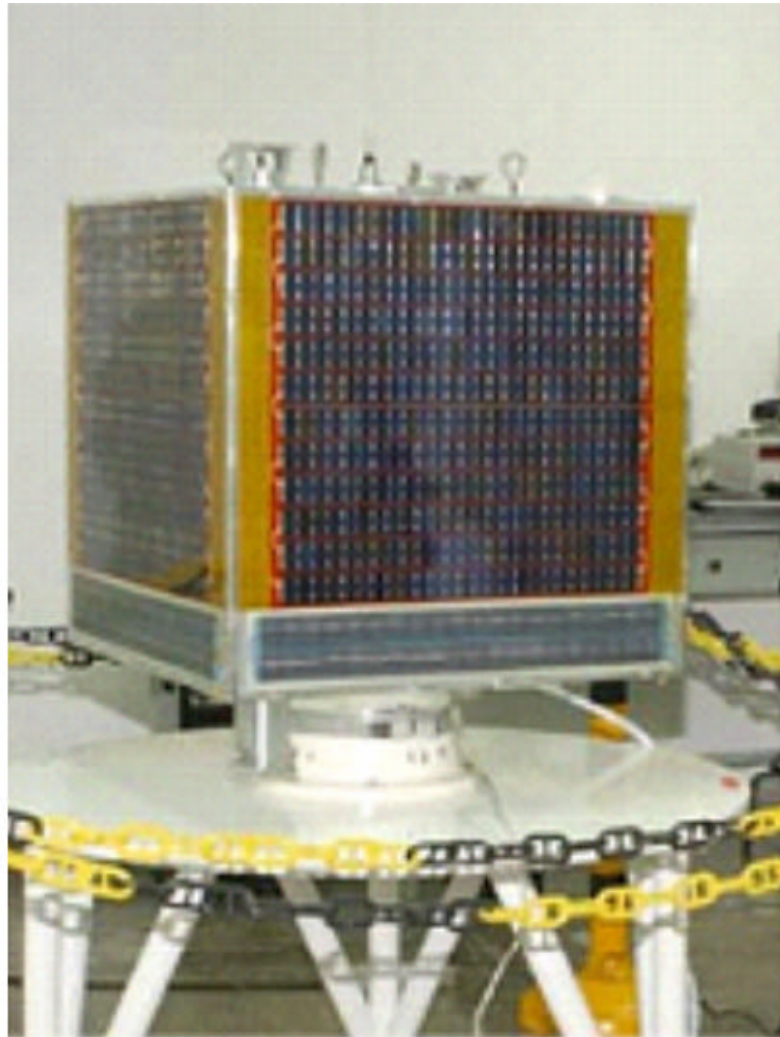

Figure 8 SATEC, the Technological Application Satellite, Destroyed by the VLS Accident in 2003

After the SACI-2 loss the SACI series has been discontinued. Another attempt to use the VLS resulted in the third accident. Again the problem was ignition (this time an unexpected ignition) and caused the rocket to burn on the launching pad. The accident causes 21 deaths, among technicians and engineers. Table 4 shows the launch failures that characterize the attempts to validate the Brazilian VLS.

**TABLE 4
SUMMARY OF VLS LAUNCHES**

Launchings Date	Payload	Comments
Nov 02 1997	SCD-2a	Failure: one 1-stage motor filed
Dec 1999	SACI-2	Failure: second stage failed to ignite
	SATEC UNOSAT	Burned on the launch pad before launch on Aug 22 2003. 21 people were killed. A strap-on booster ignited prematurely and destroyed the rocket and the launch pad.

The third accident caused two spacecraft losses, the SATEC and the UNOSAT (developed by undergraduate students) satellites. SATEC was a technological satellite planned to test the technological equipment embarked in the VLS. The SATEC was a 60 Kg box shaped (66 X 61 cm) satellite to orbit at 750 Km altitude. The spacecraft is shown in Figure 8 The satellite should have tested four technological systems on board:

1. a battery,
2. a PCU (Power Conditioning Unit),
3. a receiver (global positioning system)
4. a high frequency transmitter.

The satellite structure, the battery, the PCU and transmitter have been developed at INPE; the solar panels and the GPS have been developed in partnership with national companies. SATEC was destroyed in a pre-launch burning of the booster two days before the planned launch, in 2003.

The UNOSAT was a student built nanosatellite composed of a FM transmitter, batteries, 4 solar panels, antenna, and a computer. The satellite was to transmit in regular intervals a message of voice and one packet of telemetry. The following data was to be transmitted:

1. Telemetry
2. Temperature of the solar panels
3. Temperatures of two reloadable batteries
4. Temperature of the transmitter and computer voltage of the batteries
5. Centripetal acceleration

The satellite had a mass of 8.83 kg and was 46 cm by 25 cm by 8.5 cm small. The nanosatellite was destroyed in the pre-launch VLS explosion. The UNOSAT design has had the AEB support and the test had been done at LIT. Figure 9 illustrates UNOSAT.



Figure 9 The UNOSAT Ready for Tests at LIT, INPE

The Equars Scientific Mission

The mission can be summarized as global scale monitoring of the Earth's equatorial low, middle and upper atmosphere and ionosphere. The main objective is to study the dynamical, photochemical and ionospheric processes in the equatorial low,

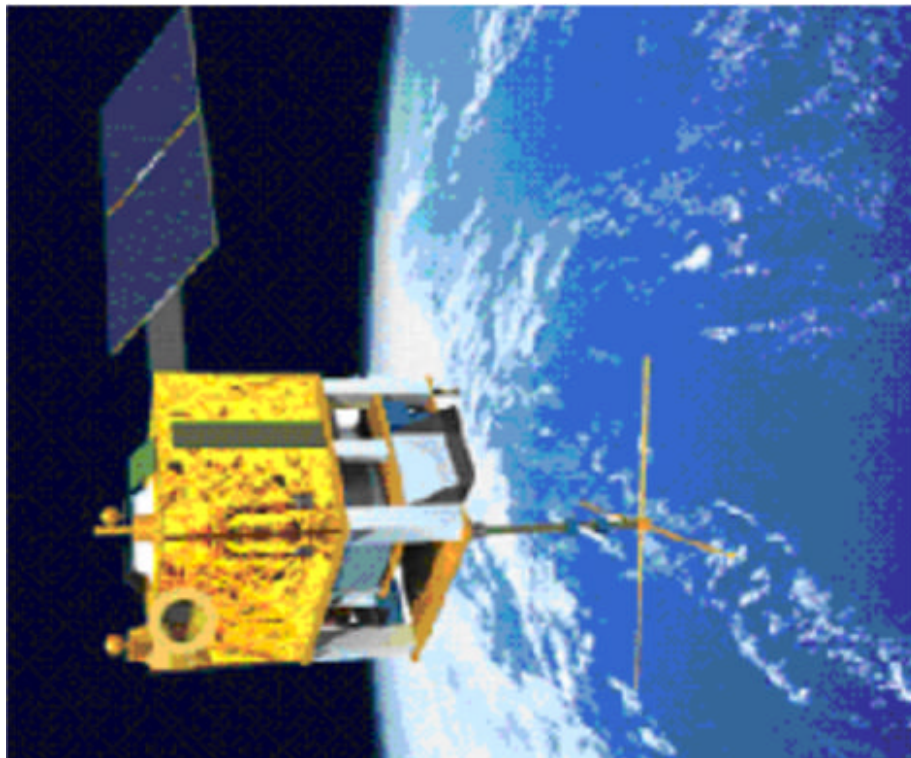

Figure 10 EQUARS Artistic Illustration

middle and upper atmosphere, with special emphasis on vertical energy transport, propagation of gravity, tidal and planetary scale waves, and the generation and development of plasma bubbles in the ionosphere. The scientific instruments to fly onboard of the EQUARS are shown in Table 5 which illustrates the international cooperation with Japan, Canada, and USA. Figure 10 illustrates the satellite with the solar array deployed configuration.

TABLE 5
SCIENTIFIC INSTRUMENTS TO FLY ONBOARD OF THE EQUARS

Experiment	Instrument	Institution	Observation parameters
GPS-IGOR	GPS receiver	Univ. Kioto, Japan	Water vapor Total Electron Content
GWIM	Airglow imager	UWO, Canada	Airglow and Gravity waves
MLTM	Temperature imager	USO, USA	Mesopause temperature
ALIS	Sprite imager	INPE, Brazil	Lightening and Sprites
IONEX	HFC, LP, ETP sensors	INPE, Brazil	Plasma density and Electron temperature
ELISA	Electrostatic energy analyzer	INPE, Brazil	Low energy electron flux
CERTO	Beacon transmitter	NRL, USA	Ionospheric irregularities Electron content Scintillations
APEX	Particle detector	INPE and USP, Brazil NASA and NRL, USA RIOKEN, Japan	High energy alfa Proton and electronic in magnosphere

The following parameters have been defined as a starting point for both scientific and engineering purposes:

1. Orbit: Equatorial, with inclination 20 ± 2 degrees/
2. Altitude: 700 – 800 km (LEO),
3. Total mass: 130 kg,
4. Available volume for Payload: 60 x 70 x 30 cm,
5. Attitude Control: active 3 axis control.
6. Position knowledge: +/- 1 km (3 sigma)
7. Pointing: Nadir
8. Pointing knowledge: 0.05 deg. (3 sigma)
9. Stability: 0.015 deg/sec.
10. Power Available to the Payload : 30 W

11. Memory available to the payload: 800 Mbits/24 hours

The Attitude and Orbit Control Subsystem (AOCS) provides attitude control in a three-axis stabilized mode and on-board orbit propagation³¹. The AOCS subsystem also performs on-board orbit determination from GPS position data, when available from GPS payload instrument. This subsystem includes the AOCS software, which runs on the On-Board Computer (OBC), and all of the sensors and actuators that are needed to maintain control in all modes.

The EQUARS spacecraft (S/C) operating modes are:

1. OFF: The satellite is completely un-powered.
2. Launch: This mode corresponds to the launch phase, when powering is permitted during launch, and as an intermediate mode for testing the integrated satellite on ground. This mode is achieved by the removal of the POWER_ON strap from the umbilical connector. In this mode the S/C is able to receive commands to proceed to AIT, OFF or Safe Modes and to deploy the solar panels in case of failure of the corresponding automatism.
3. AIT (Assembly Integration and Testing): This mode is used on ground, for testing the integrated satellite. Transition to this mode is done by command from Launch Mode.
4. Safe Mode: The Safe operating mode shall place the S/C automatically in a stable safe condition, pointing the solar panel to the Sun and the instruments boresight and battery face away from the Sun, with minimal power consumption, and capable of receiving commands. This mode is used for initial Sun acquisition (which includes the deployment of the solar panels and turn ON of the transmitter), and in contingency situations, after automatic detection of anomalies, while remedial action is sought. Transition to this mode from Launch Mode is done by either the removal of the Separation Strap or by ground command.
5. Attitude Acquisition Mode: This is an intermediate mode, from Safe mode to Nominal operation mode. At the end of this phase, the S/C shall be pointed to Nadir. In this mode, the Payload equipment shall be OFF. This mode is achieved from Launch Mode by ground command.
6. Nominal Mode: In this mode, achieved from Attitude Acquisition Mode by ground command, all S/C equipment, including Payload, are in their final operating configuration. The S/C shall be pointed to Nadir, and full pointing performance is maintained.

The transition from the Safe mode to other operation modes shall be done via telecommand only. Transition to Safe Mode from Nominal or Acquisition Modes shall occur in case of anomalies detected by either the AOCS or OBDH (On Board Data Handling) subsystems. All on-board operations during Sun and Earth attitude acquisition phase shall be performed automatically. The mode transition is illustrated in the diagram shown in Figure 11. The EQUARS shall be launched by 2007.

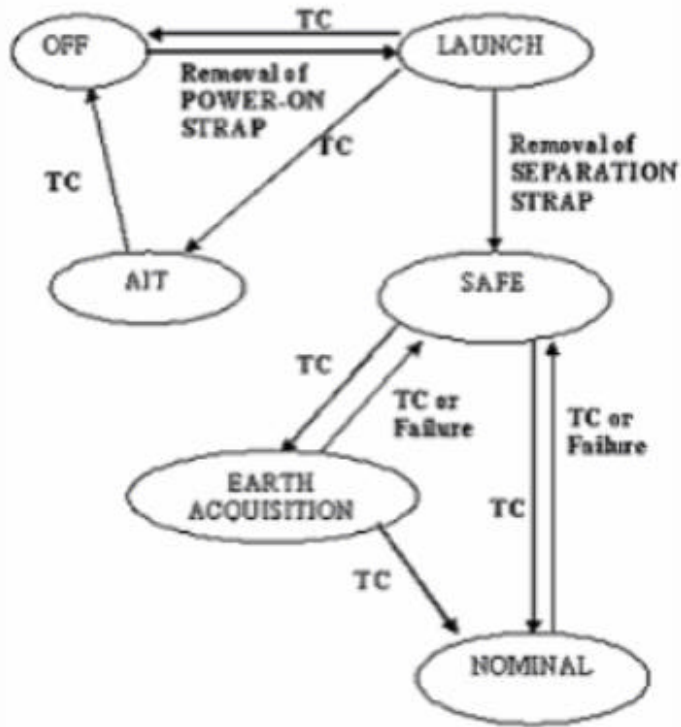

Figure 11 EQUARS Transition Modes Diagram

THE MIRAX MISSION PROPOSAL

The MIRAX (Monitor e Imageador de Raios-X), is an X-ray astronomy satellite mission proposed by the high energy astrophysics group at INPE to the Brazilian Space Agency. MIRAX is to involve an international collaboration that includes, besides INPE,

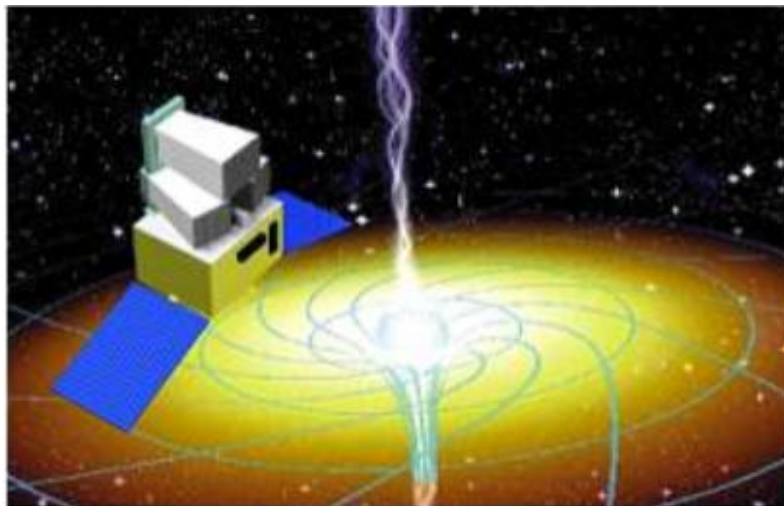

Figure 12 MIRAX Artistic Illustration

the University of California San Diego, the University of Tuebingen in Germany, the Massachusetts Institute of Technology and the Space Research Organization Netherlands. The MIRAX payload is being planned to have two identical hard X-ray cameras (10 -200 keV) and one soft X-ray camera (2-28 keV), both with angular resolution of ~ 5 -6 arcmin. The basic objective of MIRAX is to carry out continuous broadband imaging spectroscopy observations of a large source sample (~ 9 months/yr) in the central Galactic plane region. This will allow the detection, localization, possible identification, and spectral/temporal study of the entire history of transient phenomena to be carried out in one single mission. MIRAX will have sensitivities of ~ 5 mCrab/day in the 2-10 keV band (~ 2 times better than the All Sky Monitor on Rossi X-ray Timing Explorer) and 2.6 mCrab/day in the 10-100 keV band (~ 40 times better than the Earth Occultation technique of the Burst and Transient Source Experiment on the Compton Gamma-Ray Observatory). The MIRAX spacecraft will weigh about 200 kg and is expected to be launched in a low-altitude (~ 600 km) circular equatorial orbit around 2007/2008. Figure 12 is an artistic illustration of MIRAX.

MIRAX Scientific Objectives

The main scientific goals of MIRAX are based on a unique capability of the mission: continuous viewing (at least for 9 months) of a rich region of X-ray sources. The fully coded field-of-view (FCFOV) for the hard X-ray imager will be $39^\circ \times 6^\circ$ ($58^\circ \times 26^\circ$ FWHM), centered on the Galactic Center and with the longer axis aligned with the Galactic Plane. This will not only provide an unprecedented monitoring of the X-ray sky through simultaneous spectral observations of a large number of sources, but will also allow the detection, localization, possible identification, and spectral/temporal study of the entire history of transient phenomena to be carried out in one single mission. MIRAX will have sensitivities of < 5 mCrab/day in the 2-10 keV band (~ 2 times better than the All Sky Monitor on RXTE) and 2.6 mCrab/day in the 10-100 keV band (~ 40 times better than the Earth Occultation technique of the Burst and Transient Source Experiment on the Compton Gamma Ray Observatory).

THE MAPSAR MISSION PROPOSAL

The MAPSAR (Multi-Application Purpose SAR - Synthetic Aperture Radar)³² is a Brazilian-German mission proposal for a light and innovative L-band SAR sensor, based on INPE's Multi-Mission Platform - PMM (500 kg class spacecraft). The main objectives of MAPSAR are the assessment, management, and monitoring of natural resources. The mission is currently under investigation by INPE and DLR in a phase A study as a follow up of a preceding successful pre-phase A study. The phase A study is planned to be finished by the end of 2005. The key component of the SAR instrument is the SAR antenna (elliptical parabolic reflector antenna). L-band (high spatial resolution, quad-pol) has been selected for the SAR sensor as optimum frequency accounting for the majority of Brazilian and German user requirements. The MAPSAR mission is tailored to optimally support the potential user groups in both countries taking into account the present status of current and planned SAR spaceborne programs, which should be

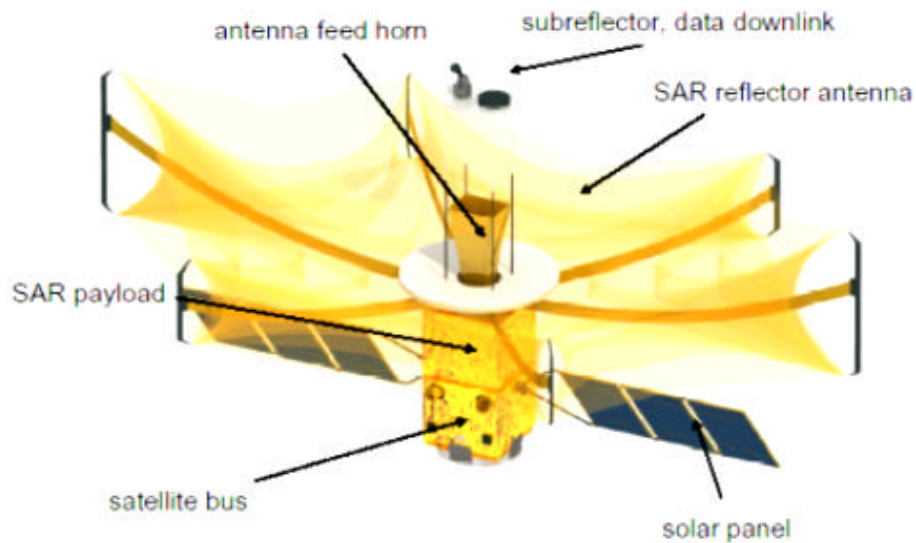

Figure 13 MAPSAR Satellite In-Orbit Configuration

complemented by the special mission characteristics of MAPSAR. The MAPSAR concept philosophy requires the satellite to combine below cost and shorter schedule with high reliability. Figure 13 illustrates the satellite in-orbit configuration. The MAPSAR mass budget is shown in Table 6.

**TABLE 6
MAPSAR MASS BUDGET**

Sub-System	Mass (Kg)
Mechanical Structure	30.0
Thermal Control	04.0
Radar Sensor & Data Acquisition	193.36
Total Mass	270.0
Specified Mass	280.0
Nominal Margin	+ 9.9

THE CHINA BRAZIL EARTH RESOURCE SATELLITE (CBERS) PROGRAM

The governments of Brazil and China signed in July 6th, 1988 a partnership agreement between INPE and CAST (Chinese Academy of Space Technology) for the

development of two advanced remote sensing satellites, named CBERS Program (China-Brazil Earth Resources Satellite)³³. By joining financial and technological resources between Brazil and China in an investment larger than US\$ 300 millions, a system of split individual responsibilities (30% Brazilian and 70% Chinese) was set up, aiming at the installation of a complete remote sensing system at an international level. The CBERS Program envisaged at its beginning only two remote sensing satellites, CBERS-1 and 2.



Figure 14 CBERS-1 and the SACI-1 Piggyback Satellite Launching from TLSC, China

The success of CBERS-1 and CBERS-2 launches by the Long March 4B launcher and the perfect operation of the satellites generated immediate effects. Both governments decided to expand the initial agreement by including another two satellites of the same kind, CBERS-3 and CBERS-4, as the second stage of the Sino Brazilian cooperation effort.

The CBERS family of remote sensing satellites brought significant scientific advances to Brazil. The SACI-1 micro satellite developed at INPE was launched as a piggyback payload together with the CBERS-1. The CBERS-1 launching occurred on October 14, 1999, at 1:15 A.M. (Brasília local time), aboard the Long March 4B rocket, from the Taiyuan Satellite Launch Center (TSLC), China. The satellite was placed in a polar orbit of 98° inclination with respect to the Equator. The launching illustration is shown in Figure 14. The successful launch of CBERS-2 satellite occurred on Oct 21, 2003.

The CBERS-1 and CBERS-2 images are used for deforestation and fires control in the Amazon region and for monitoring of hydrological resources, agricultural areas, urban growth and ground occupation.

Thanks to the CBERS program, Brazil acquired the capability of operating large satellites of a complexity much larger than that of the Data Collection Satellites (SCDs family). A large step was taken in the qualification of Brazilian technical and research personnel. The Tracking and Control Center (CRC – Centro de Rastreo e Controle) is responsible for CBERS satellite operation. Its infrastructure is composed by the Satellite Control Center (CCS – Centro de Controle de Satélites), located at INPE in São José dos Campos (Figure 15), and by the ground stations of Cuiabá (MT), shown in Figure 16, and Alcântara (MA).



Figure 15 Satellite Control Center, INPE

The CBERS satellite is composed of two modules. The payload module houses the optical system (CCD - High Resolution CCD Cameras, IRMSS - Infra-Red Multispectral Scanner e WFI - Wide Field Imager) and the electronic system used for Earth observation and Data Collection.



Figure 16 Antennas of Cuiabá Data Reception and Recording Station

The service module incorporates the equipment that ensures the power supply, control, telecommunications and all other functions needed for the satellite operation. A CBERS detailed view is illustrated in Figure 17. The 1100 W of electrical power needed to operate the onboard equipment are obtained through solar panels that are deployed when the satellite is in orbit and continuously oriented towards the sun by automatic control.

In order to provide the stringent pointing accuracy needed by the sensor systems that will take high resolution images from a distance of about 800 km, the satellite is equipped with a sensitive attitude control system, complemented by a set of hydrazine thrusters which are also used in the eventual satellite orbit correction maneuvers. The internal data used to monitor the satellite health are collected and processed by a distributed computer system before being transmitted to the Earth. An active and passive thermal control system provides the appropriate environment for operation of the sophisticated onboard equipment.

The CBERS polar orbit is sun-synchronous and the altitude is 778 km. The satellite completes about 14 revolutions per day. The local solar time at the equator crossing is always 10:30 A.M., providing the same solar illumination conditions for comparing images. It takes 26 days for the satellite to revisit the same Earth location. This is the time necessary to image the entire Earth with the CCD and the IRMSS cameras. CBERS carries on a WFI camera. By using this camera, which is able to take images 890 km wide, the required time for global coverage is 5 days. The satellite main features are shown in Table 7.

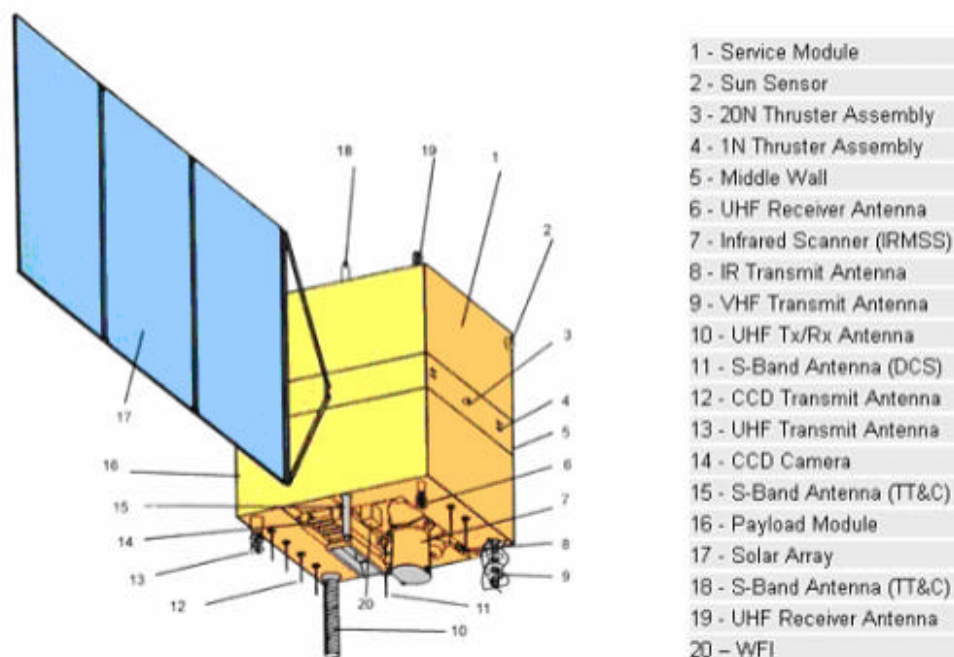

Figure 17 CBERS Detailed View

TABLE 7
CBERS MAIN FEATURES

CBERS main features	
Mass/Size	<i>1450 Kg / 2.0 x 8.3 x 3,3 (m), solar panel deployed</i>
Solar array size	<i>6.3 x 2.6 m</i>
Stabilization	<i>3-axis</i>
Lifetime	<i>2 years</i>
Altitude / Orbit inclination	<i>778 Km / 98.5 °</i>

CONCLUSION

This paper presented a survey of the Brazilian satellites. The Brazilian space program started in 1961. Since the 1980's the space program is being conducted according to the MECB, the Brazilian Complete Space Mission. This program establishes the objectives of the development of four satellites development including the launching capabilities and ground facilities (integration and test laboratory – LIT and a tracking antenna system) to test, integrate, communicate with, and operate the satellites. Two satellites have been launched and operate successfully in orbit up to date (SCD-1 and SCD-2). Three satellites have been lost. One of them, launched as a piggyback satellite by the Long March 4B, a Chinese rocket, is still in orbit. However, the mission was lost because of a failure probably in the spacecraft communication system or the on-board computer. The others spacecraft (SCD-2A, SACI-2) were lost because of two launching failures (VLS ignition failures). The VLS third accident caused the destruction of one application satellite (SATEC), and one student nanosatellite, the UNOSAT. This last accident also caused 21 deaths among engineers and technicians. Currently one satellite, the EQUARS is in development and two others, the MIRAX and the MAPSAR are under studies at INPE. The paper also presents the Brazil China joint satellite program that already has accomplished the launching of the CBERS-1 and CBERS-2 (China Brazil Earth Resource Satellites). These satellites are operating successfully in orbit.

REFERENCES

1. Dias Jr, O. P “An Overview of the MECB Program”, ABCM-J. of the Braz. Soc. Mechanical Sciences, Vol. XVI, Special Issue, 1994, pp. 3-9
2. Carleial, A. B. “The MECB Satellite Program”, VI Japan-Brazil Symposium on Science and Technology, Vol. III, 1988, pp 99-102
3. Bastide, Roger *Brasil: terra de contrastes*, São Paulo, Difel, 1959
4. Lambert, Jaques; *Os dois brasis*. Companhia ed. nacional, SP, 1980
5. Vilares, Henrique Dumont - *Quem deu asas ao homem*, Inst. Nacional do Livro, Rio de Janeiro, 1957

6. http://www.centennialofflight.gov/essay/Commercial_Aviation/france/Tran21G1.htm, accessed: 2005
7. Rios Neto, A. et al "A proposal for the attitude Determination of the MECB Remote Sensing Satellite", VI Japan-Brazil Symposium on Science and Technology, Vol. III, 1988, p. 165-169
8. Fonseca, I.M. and Ribeiro, J.F. "On the Dynamics and Control of the First Brazilian remote sensing satellite, Proceedings of the First ESA International Conference", ESTEC Noordwijk, The Netherlands, 4-7 June, 1991, ESA SP-323
9. Fonseca, I.M.; Ribeiro, J.F. "The First Brazilian Remote Sensing Satellite – Dynamics and Control Study", PACAM III, 4-8 January, 1993, p. 507-510
10. Fonseca, I. M and Souza, P. N. "Partially Filled Viscous Ring Nutation Damper Dynamics Analysis and Experimental Approach for Modeling Validation". In: XVII International Symposium on Space Technology and Science, 1990, Kagoshima. Proceedings of the XVII International Symposium on Space Technology and Science. Kagoshima, 1990
11. Fonseca, I. M. and Souza P. N. "Movimento Rotacional de um Corpo Rígido Dotado de um Amortecedor de Nutação Anular Viscoso – Abordagem Teórica e Experimental", ABCM- Anais XCOBEM, 5-8 dezembro, Rio de Janeiro, Brasil, 1989, p. 597-600
12. De Oliveira Lino, C. and Pereira Solano, C. "The LIT-Integration and Test Laboratory Conception Dedicated to Small Satellites Programs", 4th International Symposium on Small Satellite Systems, September 14-18, Antibes-Juan Les Pins, France, 1998
13. Fonseca Lopes, R. V; Orlando, V.; Kuga, H.K. and Guedes, U.T.V. "Attitude Determination of the Brazilian Satellite, SCD1", RBCM - J. of the Braz. Soc. Mechanical Sciences, Vol. XVI, Special Issue, 1994, p. 11-23
14. Carrara, V. and Guedes U.T.V. "Attitude Control for the SCD1 and SCD2", RBCM - J. of the Braz. Soc. Mechanical Sciences, Vol. XVI, Special Issue, p. 83-87
15. Kono, J. and Santana, C.E.; SCD1: "One Year in Orbit", RBCM - J. of the Braz. Soc. Mechanical Sciences, Vol. XVI, Special Issue, 1994, p. 96-101
16. Yamaguti, W.; Ribeiro, E.A.; Becceneri, J.C. and Itami, S.N. "Collection and Treatment of the Environmental Data with the Brazilian Satellite SCD1", RBCM - J. of the Braz. Soc. Mechanical Sciences, Vol. XVI, Special Issue, 1994, p. 205-211
17. Ambrosio, A.M. and Kuga, H.K. GAN: "An Automated System for Acquisition and Tracking of Satellites by Ground Station", RBCM - J. of the Braz. Soc. Mechanical Sciences, Vol. XVI, Special Issue, 1994, 248-253
18. Orlando V.; Rozenfeld P.; Miguez, R.R.B. and Fonseca, I.M. "Brazilian Data Collecting Satellite Simulator", 18th International Symposium on Space Technology and Science, Kagoshima, Japan, 1992
19. Kuga, H.K. and Kondapalli, R.R. SCD1 "Orbit Determination System: Pre-Launch Preparation", LEOP Performance and Routine Operations, RBCM - J. of the Braz. Soc. Mechanical Sciences, Vol. XVI, Special Issue, 1994, p. 472-477
20. Kuga, H.K. and Kondapalli, R.R. "Analysis, Testing and Assessment of the OD System for the First Brazilian Satellite", 3th International Symposium on Spacecraft Dynamics, Darmstadt, Germany, 30 Sept-04 Oct, 1991, ESA SP-326, p. 149-153

21. Kuga, H.K. and Kondapalli, R.R. "Satellite Orbit Determination: A First-hand Experience with the First Brazilian Satellite", SCD1, 44th International Astronautical Congress of the International Astronautical Federation, IAF, Graz, Austria, 16-22 Oct. 1993, Paper IAF-93-A.5.43
22. Alonso, J.D.D.; De Paula, A.R.; Caliman, J.C. and Arias R. "The On-board Computer Software for the First Brazilian Satellite", VI Japan-Brazil Symposium on Science and Technology, Vol. III, 1988, p. 165-169
23. Rozenfeld, P. "Operational Training for the Mission Operations at the Brazilian National Institute of Space Research (INPE)", 2nd International Symposium on Ground Data Systems for Space Mission Operations, SPACEOPS92, Pasadena, CA, USA, November 16-20, 1992, p. 667-671
24. Rozenfeld, P.; Orlando, V.; Schneider, E.M. "Overview of INPE's Satellite Tracking and Control Center and Main Aspects of its Debut in Satellite Operations", RBCM - J. of the Braz. Soc. Mechanical Sciences, Vol. XVI, Special Issue, 1994, p. 421-425
25. Fonseca, I. M.; Souza, P. N.; Neri, J. F. C.; Guedes, U. T. V., "Attitude dynamics and control of the brazilian scientific application satellite – SACI-1". In: *ESA International Conference On Spacecraft, Guidance Navigation and Control Systems 3.*, Noordwijk, Nov. 1996. Proceedings. Noordwijk, ESTEC, 1996, *ESA SP-381*
26. Neri, J.A.C.F, Dos Santos, W.A., Rabay, S., Fonseca, I.M, et al; "The Brazilian Scientific Microsatellite SACI-1", *Acta Astronautica*, Vol. 30, No. 9-12, November-December, 1996, *ISSN 0094-5765*.
27. Neri, J.A.C.F.; Rabay, S.; Dos Santos, W.A.; De Souza, P.N.; Fonseca, I.M.; De Paula Júnior, A.R., "Key Technological Solutions Towards The SACI-1 Microsatellite Design", Proceedings of the Tenth Annual AIAA/USU Conference on Small Satellites, September 1996
28. Fonseca, I.M. "On the Attitude Dynamics of the Second Brazilian Scientific Satellite, SACI-2", 50th International Astronautical Congress, Oct. 4 – Oct. 8, 1999, Amsterdam, The Netherlands, paper IAF-99-A.3.01
29. Fonseca, I. M.; Santos, M. C. " SACI-2 Attitude Control Subsystem". In: O. Winter; A. F. B. A. Prado. (Org.). *Advances in Space Dynamics 3 Applications in Astronautics*. 1 ed. São José dos Campos, SP, 2002, p. 197-209.
30. Fonseca, I. M.; Neri, J. A. C. F. ; Ribeiro, M. S. "After-Separation Attitude Dynamics of the Brazilian Scientific Satellite, SACI-2". *Revista Brasileira de Ciências Mecânicas*, S. P., v. 21, p. 156-163, 1999.
31. Fonseca, I. M.; Arantes Jr, G.; Bainum, P. M. "On the EQUARS Attitude Dynamics and Control, International Astronautical Congress", IAC 2004, Vancouver, 55 th IAC Final Papers. Vancouver: ZARM, 2004. v. CD I. p. 1-11.
32. Kono, J.; Paradella, W.R.; Quintino, M.M.; Valeriano, D.; Costa, M.P.F.; Schröder, R.; Puls, J.; Hajnsek, I.; Jochim, F.; Neff, T. "MAPSAR: A New L-band Spaceborne SAR Mission for Assessment and Monitoring of Terrestrial Natural Resources". In: *Simpósio Brasileiro de Sensoriamento Remoto*, 11., 2003, Belo Horizonte. Anais, São José dos Campos: INPE, 2003. pp. 1099-1106.
33. <http://www.cbers.inpe.br/en/imprensa/principal.htm> accessed: 2005